

EI 30
Sp. = 75 mm

EI 60
Sp. = 75 mm

EI 90
Sp. = 89 mm

EI 120
Sp. = 89 mm

Cliente _____ Rif. ordine / Offerta _____ Data ____ / ____ / ____ Rif. _____ Ubicazione _____

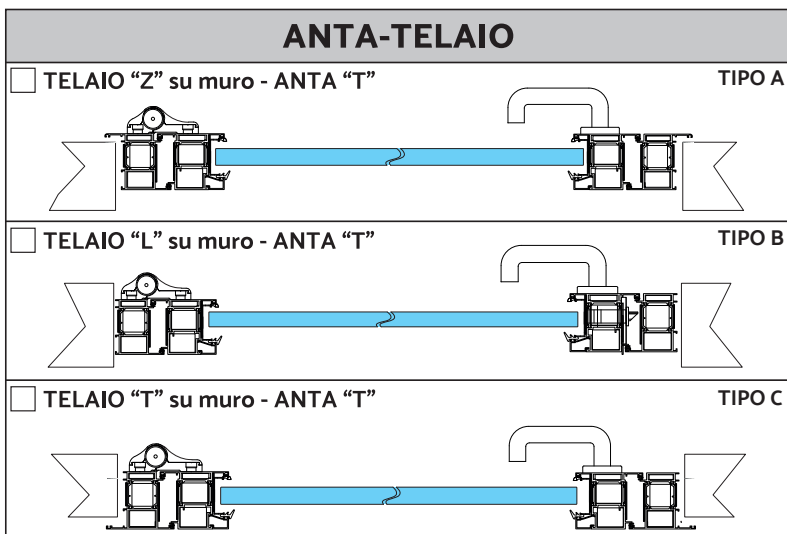
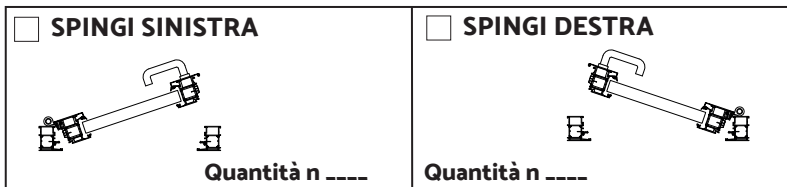
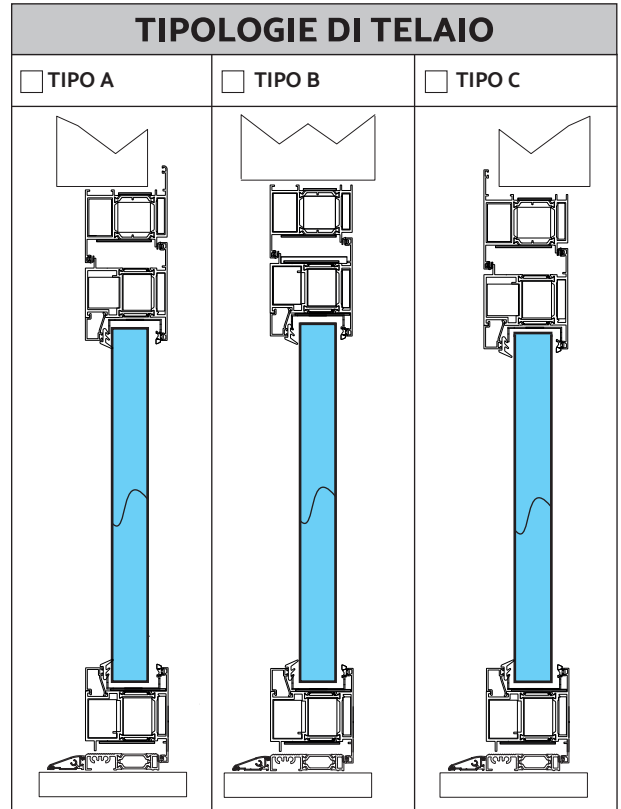
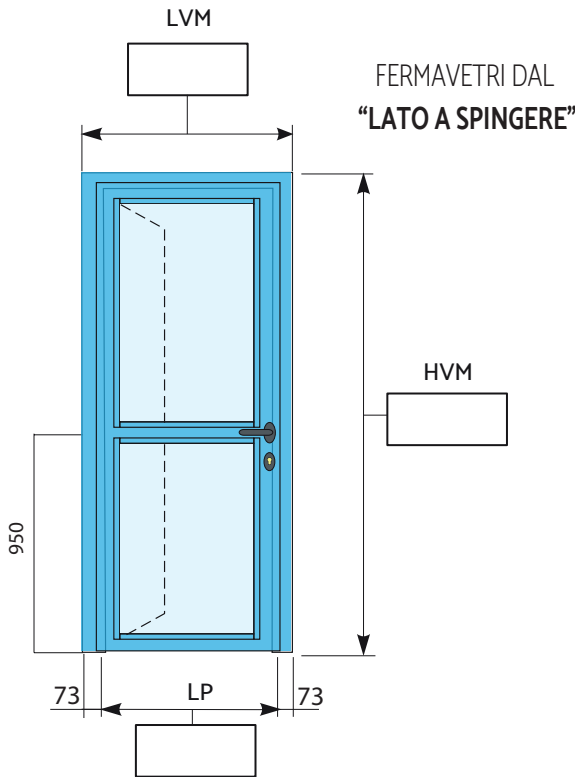

NOTE: _____

Timbro e firma per accettazione

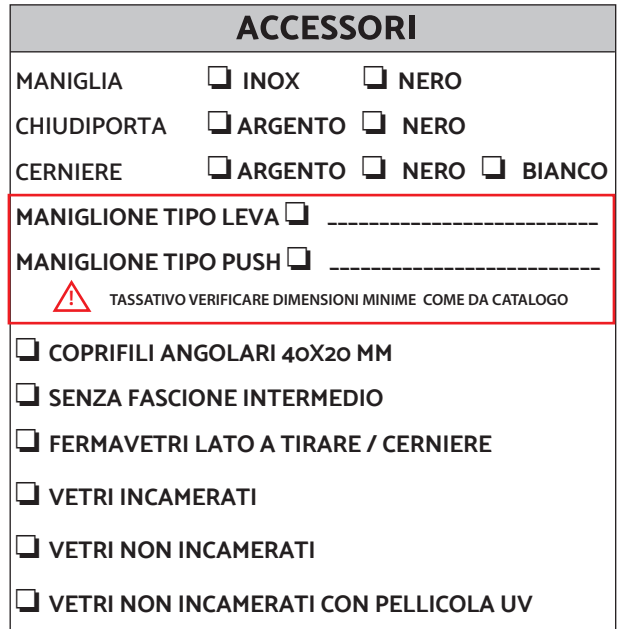

Cliente _____ Rif. ordine / Offerta _____ Data ____ / ____ / ____ Rif. _____ Ubicazione _____

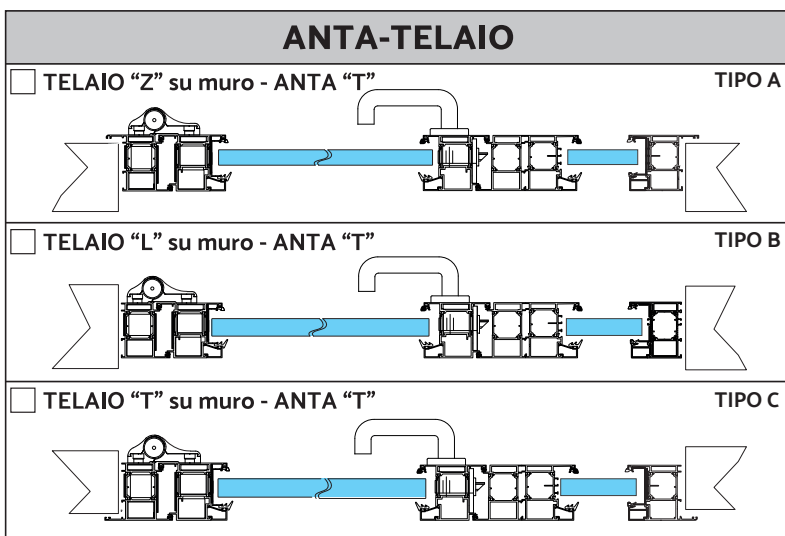
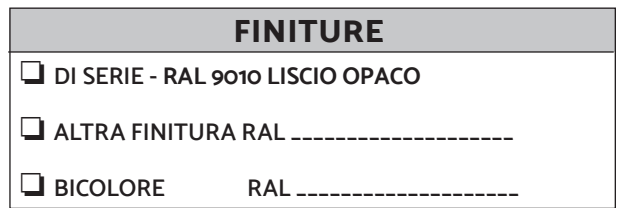
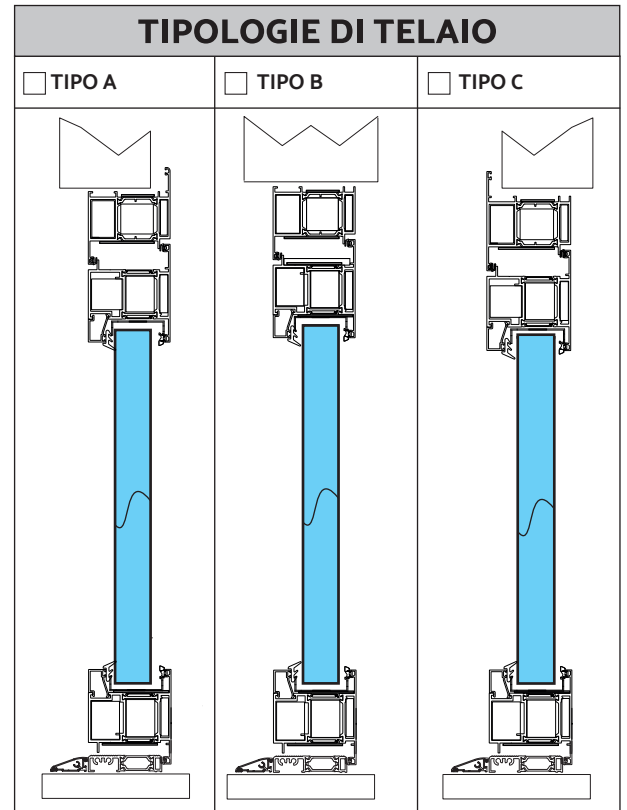
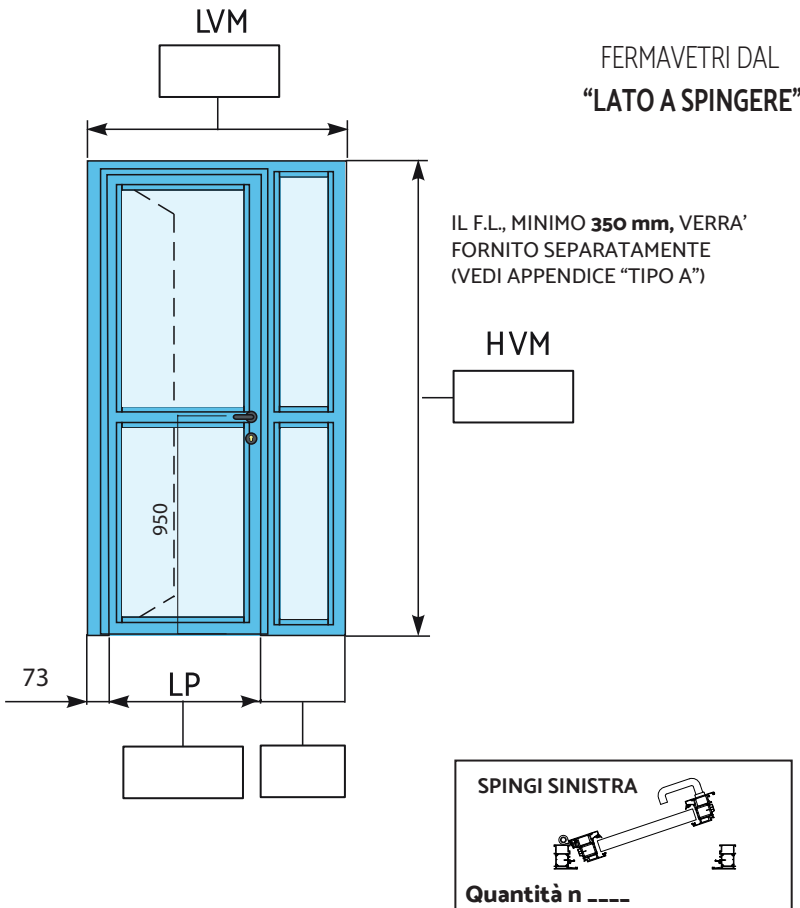

NOTE:

Timbro e firma per accettazione

- COPRIFILI ANGOLARI 40X20 MM
- SENZA FASCIONE INTERMEDIO
- FERMAVETRI LATO A TIRARE / CERNIERE
- VETRI INCAMERATI
- VETRI NON INCAMERATI
- VETRI NON INCAMERATI CON PELLICOLA UV

Cliente _____ Rif. ordine / Offerta _____ Data ____ / ____ / ____ Rif. _____ Ubicazione _____

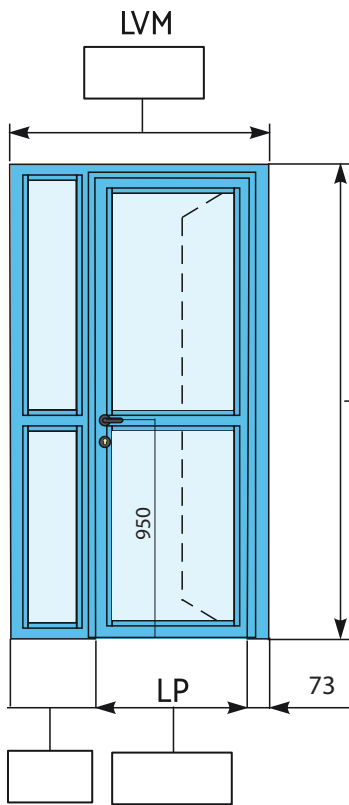

FERMAVETRI DAL
"LATO A SPINGERE"

IL F.L., MINIMO 350 mm, VERRA' FORNITO SEPARATAMENTE (VEDI APPENDICE "TIPO A")

HVM

SPINGI DESTRA

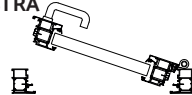

Quantità n ____

ANTA-TELAIO

TELAIO "Z" su muro - ANTA "T" TIPO A

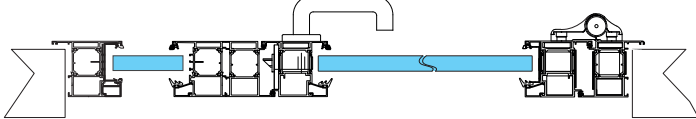

TELAIO "L" su muro - ANTA "T" TIPO B

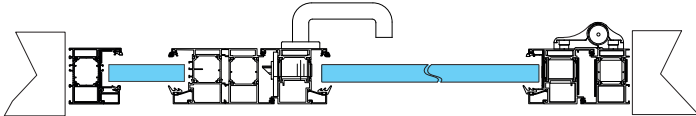

TELAIO "T" su muro - ANTA "T" TIPO C

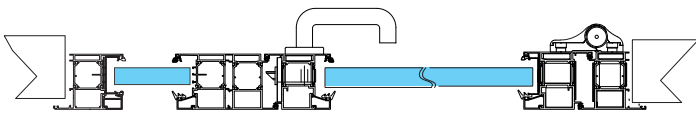

NOTE:

Timbro e firma per accettazione

Esprimere le quote in millimetri - I disegni sono esemplificativi e fuori scala - Ed. 06-2024

TIPOLOGIE DI TELAIO

TIPO A

TIPO B

TIPO C

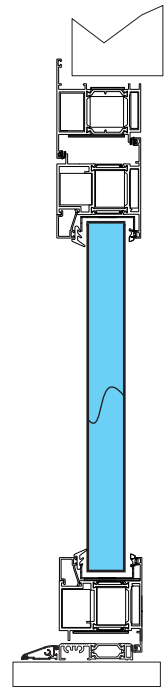
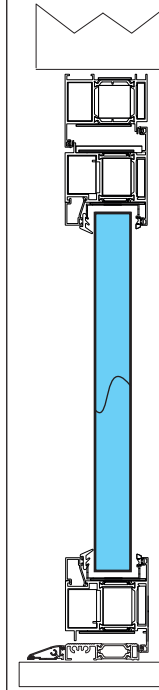
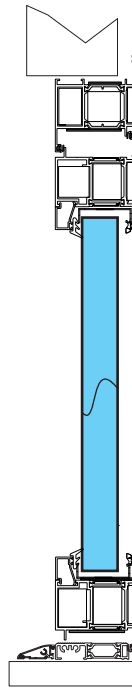

TIPOLOGIE DI FISSAGGIO

FORI DI ANCORAGGIO PER SOTTOSTRUTTURA

FORI DI ANCORAGGIO PER TASSELLI

FINITURE

DI SERIE - RAL 9010 LISCIO OPACO

ALTRA FINITURA RAL _____

BICOLORE RAL _____

ACCESSORI

MANIGLIA INOX NERO

CHIUDIORTA ARGENTO NERO

CERNIERE ARGENTO NERO BIANCO

MANIGLIONE TIPO LEVA _____

MANIGLIONE TIPO PUSH _____

TASSATIVO VERIFICARE DIMENSIONI MINIME COME DA CATALOGO

COPRIFILI ANGOLARI 40X20 MM

SENZA FASCIONE INTERMEDIO

FERMAVETRI LATO A TIRARE / CERNIER

VETRI INCAMERATI

VETRI NON INCAMERATI

VETRI NON INCAMERATI CON PELLICOLA UV

Cliente _____ Rif. ordine / Offerta _____ Data ____ / ____ / ____ Rif. _____ Ubicazione _____

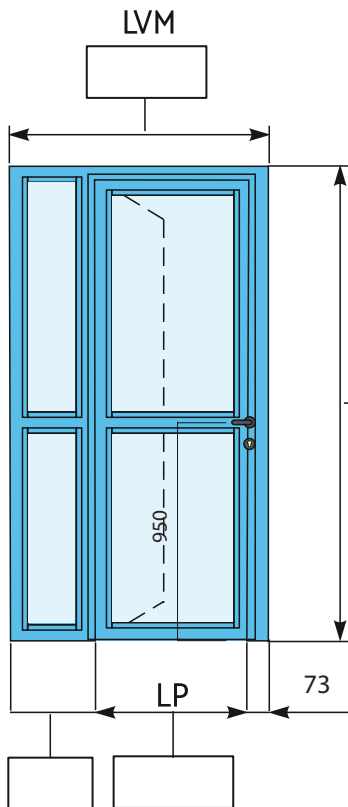

FERMAVETRI DAL
"LATO A SPINGERE"

IL F.L., MINIMO 350 mm, VERRA' FORNITO SEPARATAMENTE (VEDI APPENDICE "TIPO A")

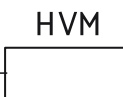

SPINGI SINISTRA

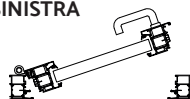

Quantità n _____

ANTA-TELAIO

TELAIO "Z" su muro - ANTA "T" TIPO A

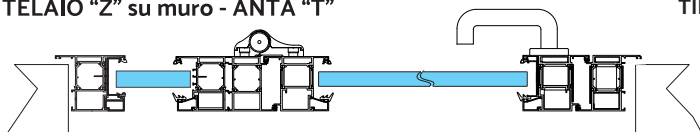

TELAIO "L" su muro - ANTA "T" TIPO B

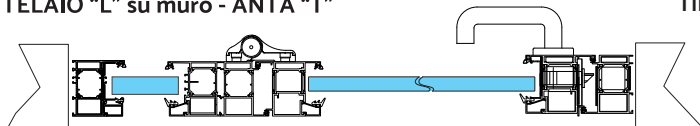

TELAIO "T" su muro - ANTA "T" TIPO C

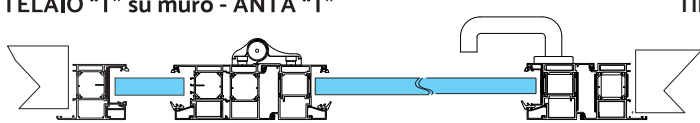

NOTE:

Timbro e firma per accettazione

TIPOLOGIE DI TELAIO

TIPO A

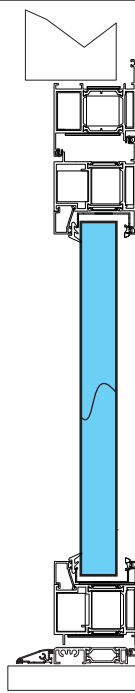

TIPO B

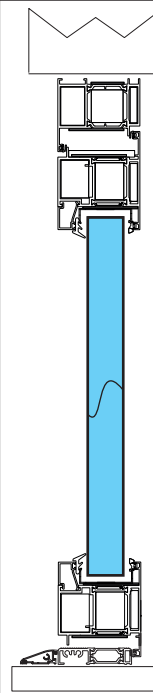

TIPO C

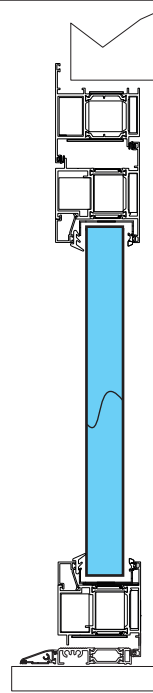

TIPOLOGIE DI FISSAGGIO

- FORI DI ANCORAGGIO PER SOTTOSTRUTTURA
- FORI DI ANCORAGGIO PER TASSELLI

FINITURE

- DI SERIE - RAL 9010 LISCIO OPACO
- ALTRA FINITURA RAL _____
- BICOLORE RAL _____

ACCESSORI

- MANIGLIA INOX NERO
- CHIUDIPIORTA ARGENTO NERO
- CERNIERE ARGENTO NERO BIANCO

MANIGLIONE TIPO LEVA _____

MANIGLIONE TIPO PUSH _____

TASSATIVO VERIFICARE DIMENSIONI MINIME COME DA CATALOGO

- COPRIFILI ANGOLARI 40X20 MM
- SENZA FASCIONE INTERMEDIO
- FERMAVETRI LATO A TIRARE / CERNIER
- VETRI INCAMERATI
- VETRI NON INCAMERATI
- VETRI NON INCAMERATI CON PELLICOLA UV

EI 30
Sp. = 75 mm

EI 60
Sp. = 75 mm

EI 90
Sp. = 89 mm

EI 120
Sp. = 89 mm

Cliente _____ Rif. ordine / Offerta _____ Data ____ / ____ / ____ Rif. _____ Ubicazione _____

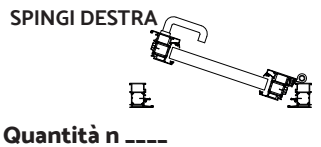
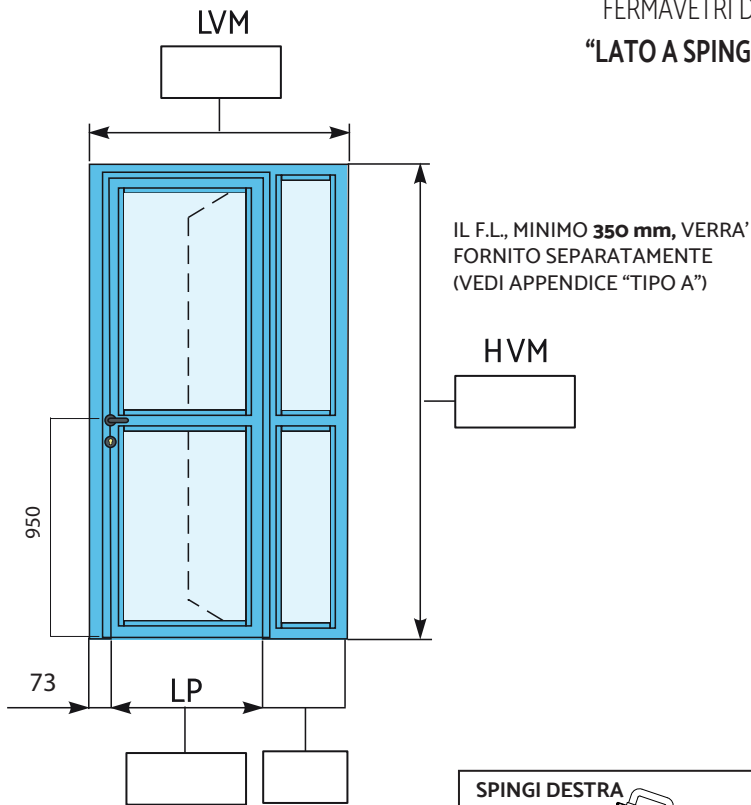

ANTA-TELAIO

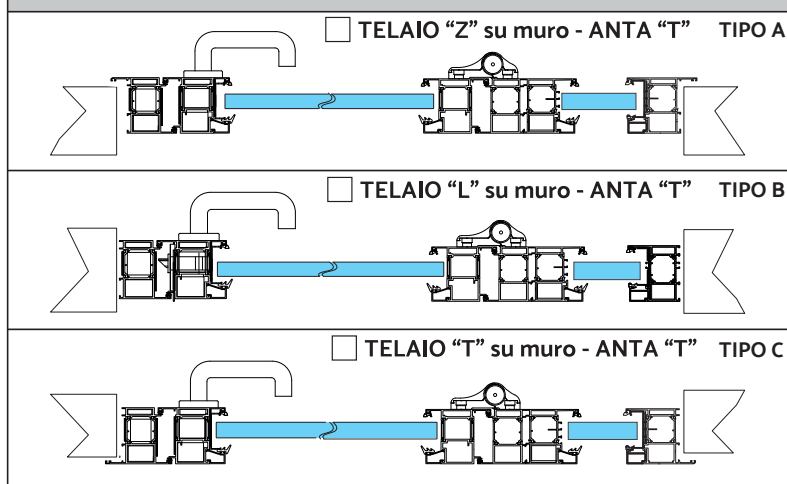

NOTE:

Timbro e firma per accettazione

TIPOLOGIE DI TELAIO

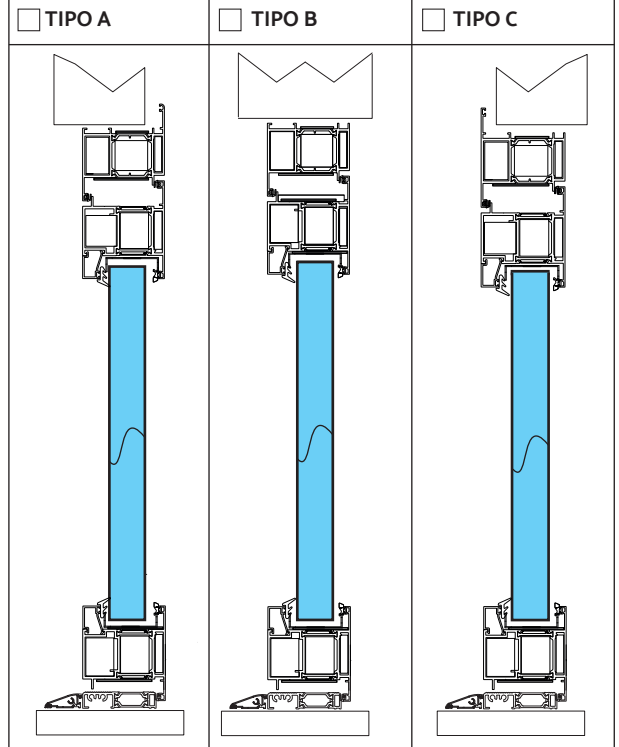

TIPOLOGIE DI FISSAGGIO

- FORI DI ANCORAGGIO PER SOTTOSTRUTTURA
- FORI DI ANCORAGGIO PER TASSELLI

FINITURE

- DI SERIE - RAL 9010 LISCIO OPACO
- ALTRA FINITURA RAL _____
- BICOLORE RAL _____

ACCESSORI

- MANIGLIA INOX NERO
- CHIUDIORTA ARGENTO NERO
- CERNIERE ARGENTO NERO BIANCO

MANIGLIONE TIPO LEVA _____

MANIGLIONE TIPO PUSH _____

TASSATIVO VERIFICARE DIMENSIONI MINIME COME DA CATALOGO

- COPRIFILI ANGOLARI 40X20 MM
- SENZA FASCIONE INTERMEDIO
- FERMAVETRI LATO A TIRARE / CERNIER
- VETRI INCAMERATI
- VETRI NON INCAMERATI
- VETRI NON INCAMERATI CON PELLICOLA UV

EI 30
Sp. = 75 mm

EI 60
Sp. = 75 mm

EI 90
Sp. = 89 mm

EI 120
Sp. = 89 mm

Cliente _____ Rif. ordine / Offerta _____ Data ____ / ____ / ____ Rif. _____ Ubicazione _____

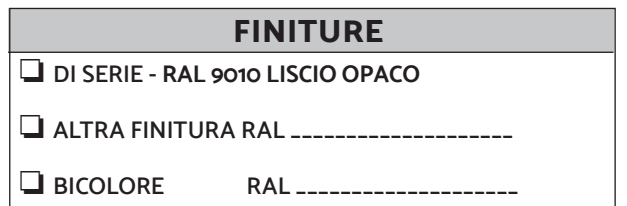
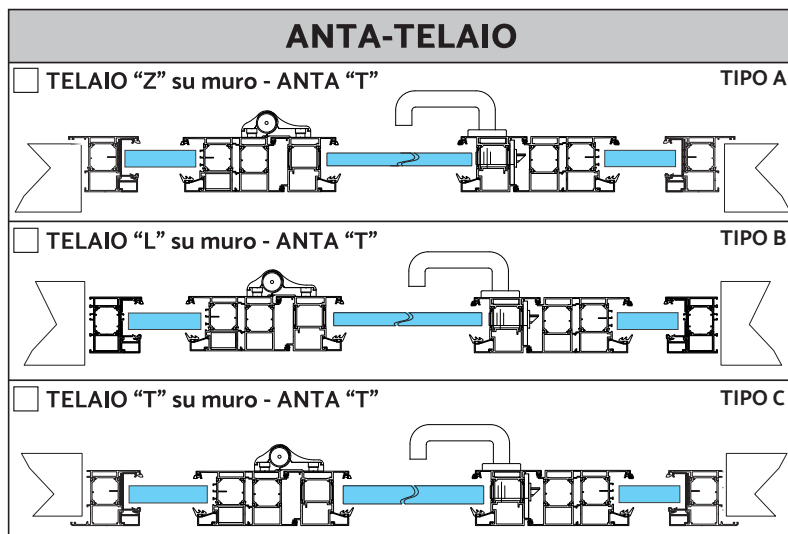
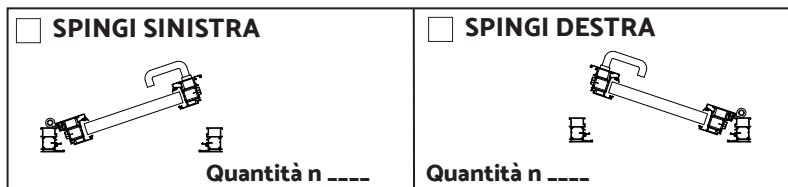
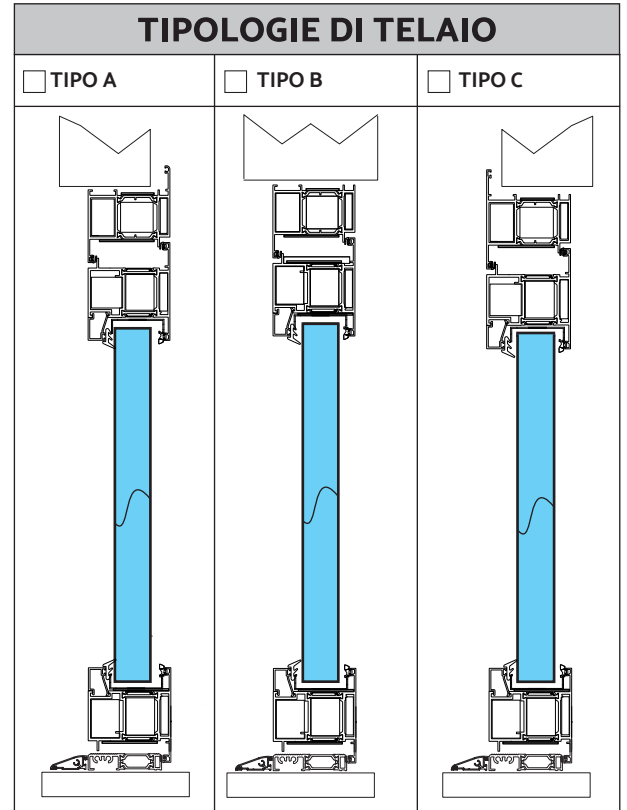
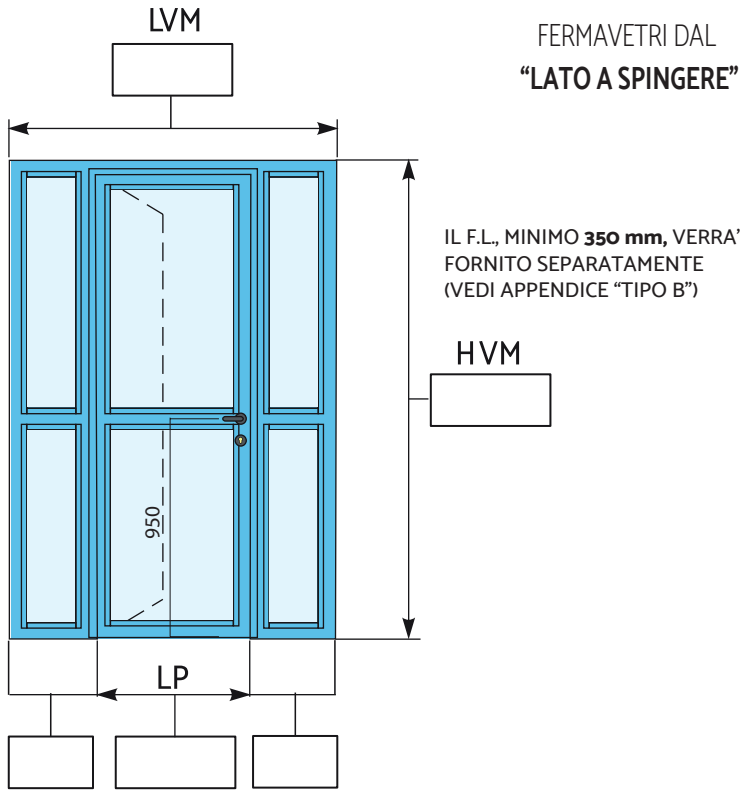

NOTE:

Timbro e firma per accettazione

- COPRIFILI ANGOLARI 40X20 MM
- SENZA FASCIONE INTERMEDIO
- FERMAVETRI LATO A TIRARE / CERNIERE
- VETRI INCAMERATI
- VETRI NON INCAMERATI
- VETRI NON INCAMERATI CON PELLICOLA UV

Cliente _____ Rif. ordine / Offerta _____ Data ____/____/____ Rif. _____ Ubicazione _____

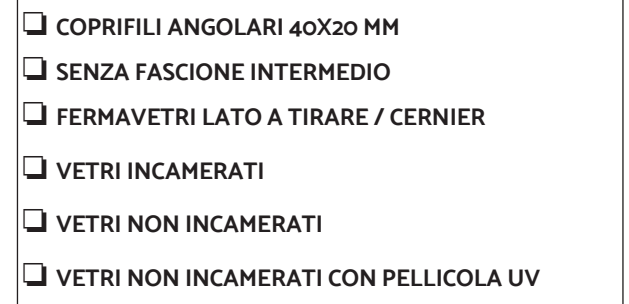
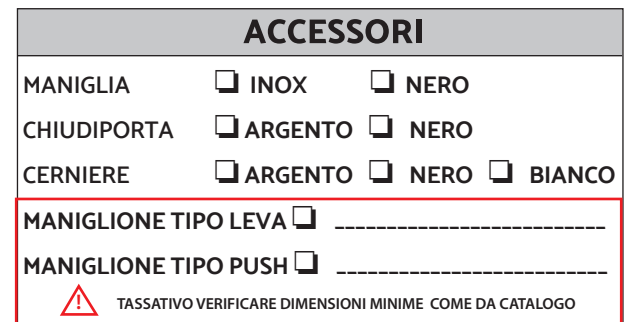
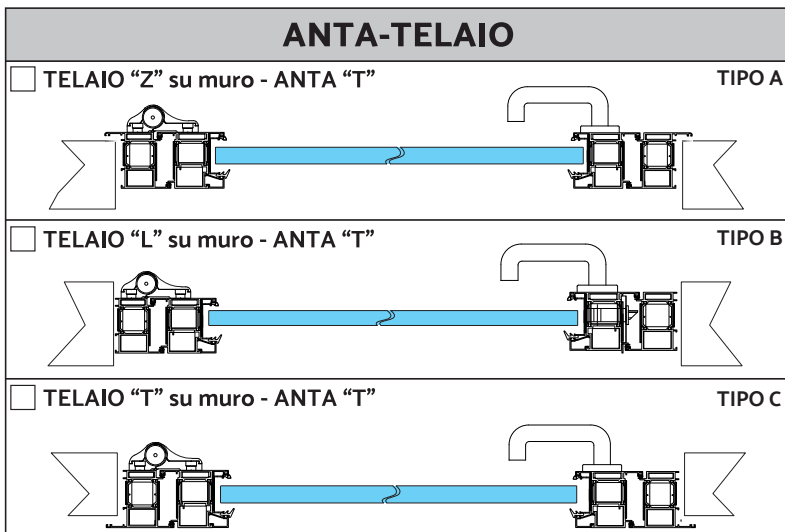
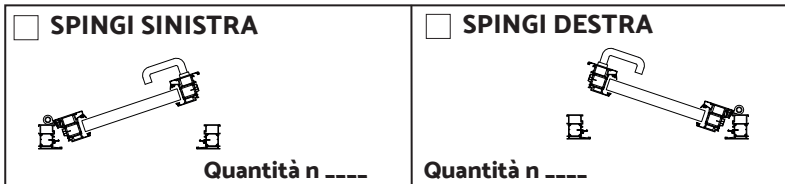
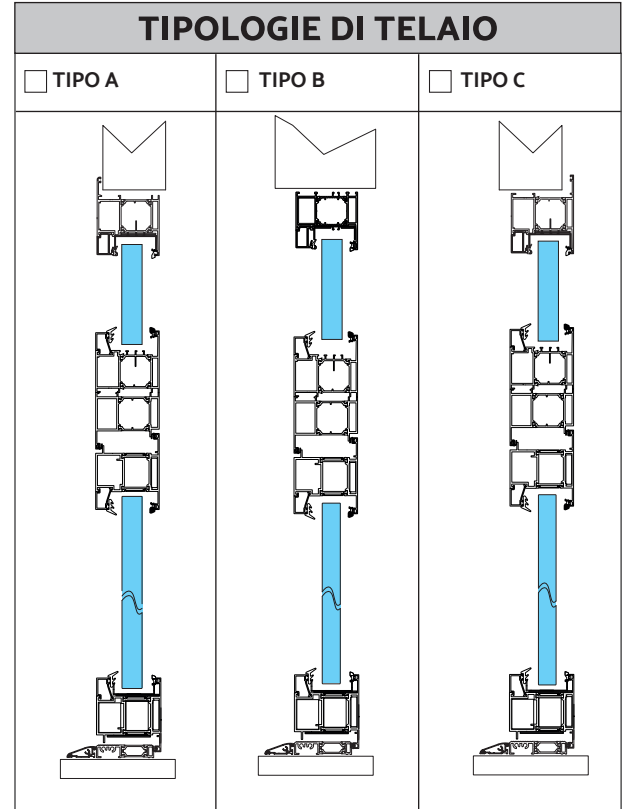
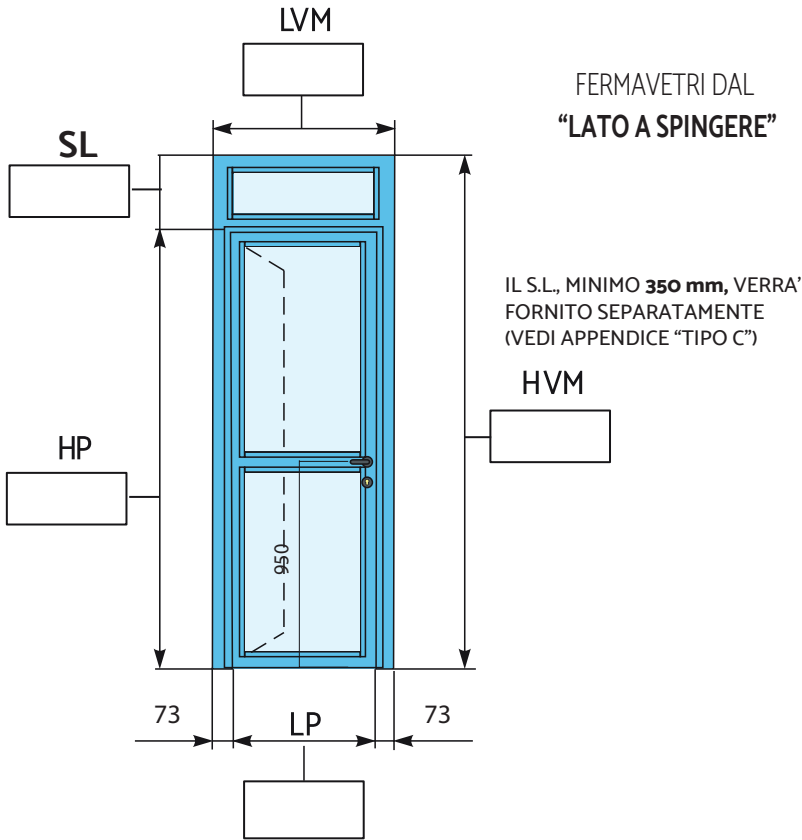

NOTE:

Timbro e firma per accettazione

Cliente _____ Rif. ordine / Offerta _____ Data ___/___/___ Rif. _____ Ubicazione _____

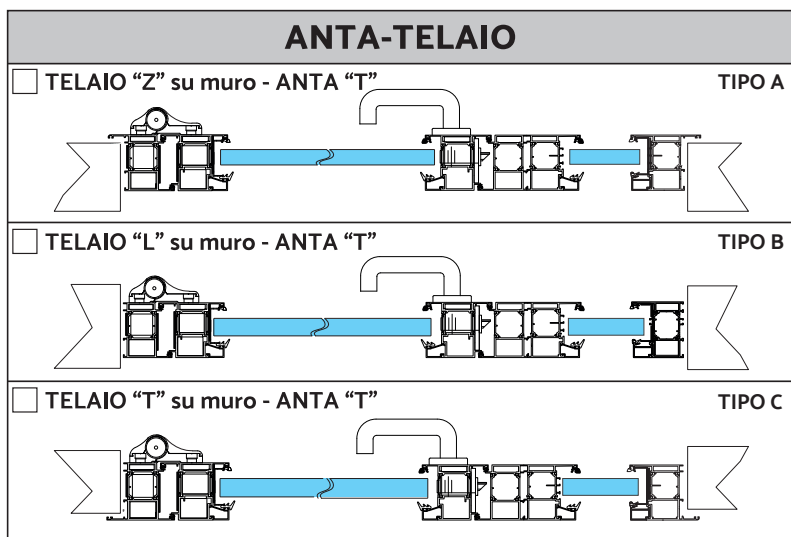
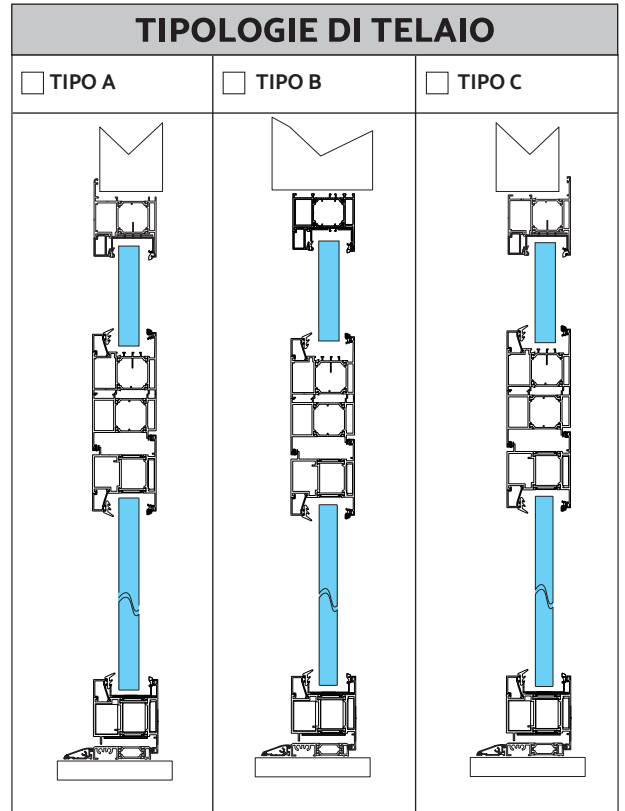
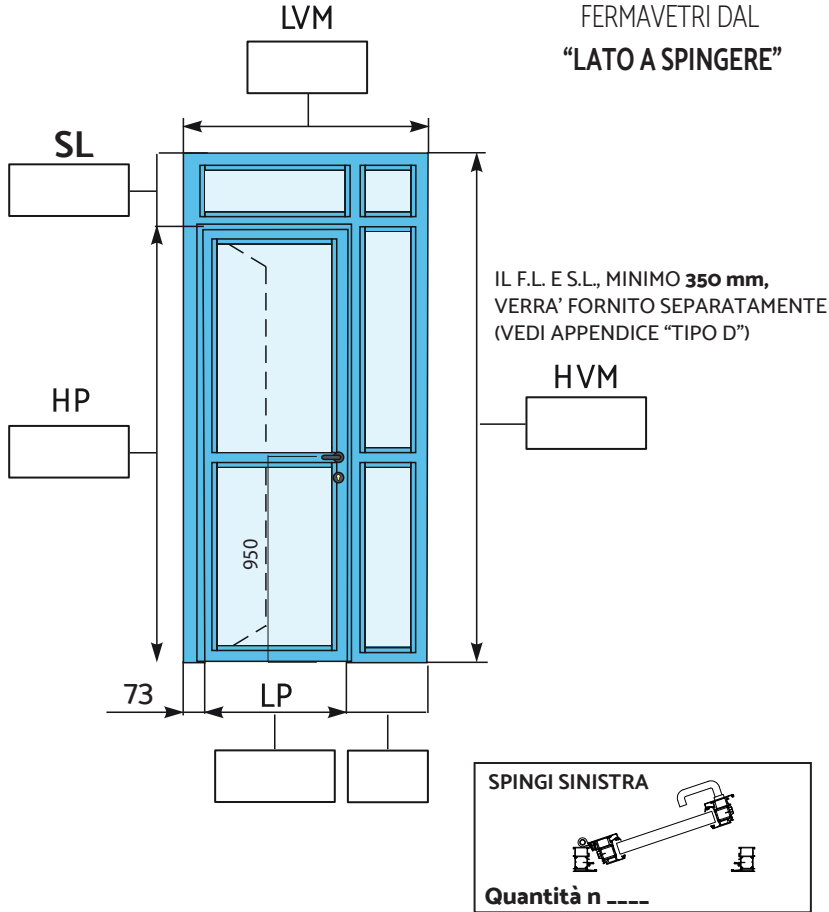

NOTE: _____

Timbro e firma per accettazione

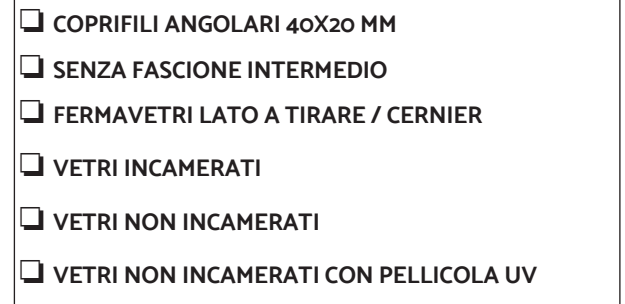

EI 30
Sp. = 75 mm

EI 60
Sp. = 75 mm

EI 90
Sp. = 89 mm

EI 120
Sp. = 89 mm

Cliente _____ Rif. ordine / Offerta _____ Data ____ / ____ / ____ Rif. _____ Ubicazione _____

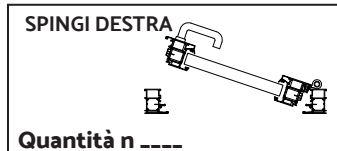
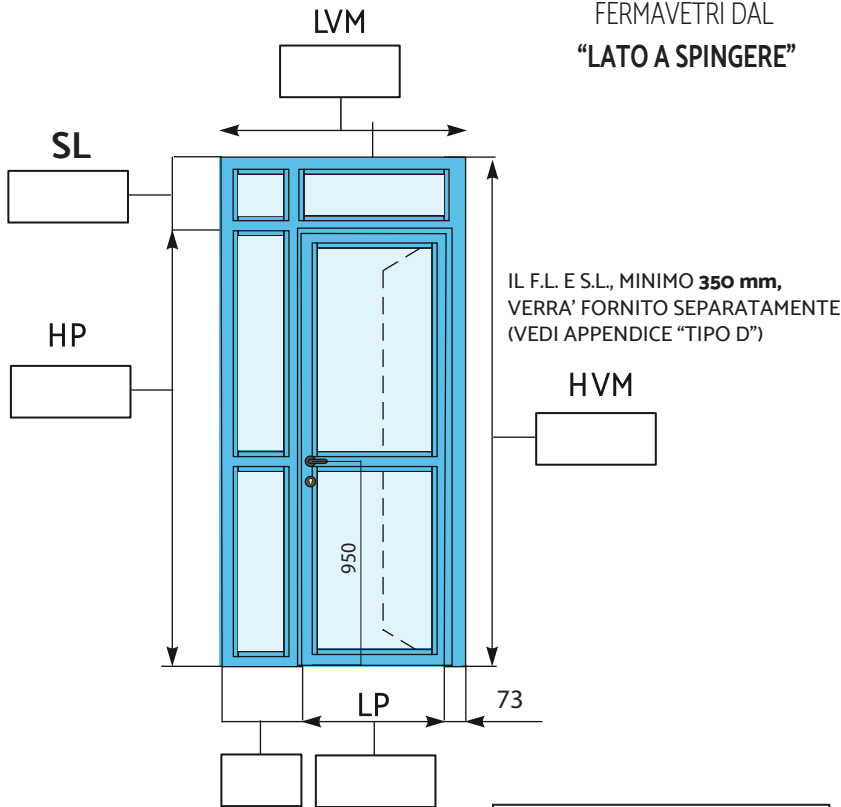

ANTA-TELAIO

- TELAIO "Z" su muro - ANTA "T" TIPO A
- TELAIO "L" su muro - ANTA "T" TIPO B
- TELAIO "T" su muro - ANTA "T" TIPO C

NOTE:

Timbro e firma per accettazione

TIPOLOGIE DI TELAIO

- | <input type="checkbox"/> TIPO A | <input type="checkbox"/> TIPO B | <input type="checkbox"/> TIPO C |
|---------------------------------|---------------------------------|---------------------------------|
| | | |

TIPOLOGIE DI FISSAGGIO

- FORI DI ANCORAGGIO PER SOTTOSTRUTTURA
- FORI DI ANCORAGGIO PER TASSELLI

FINITURE

- DI SERIE - RAL 9010 LISCIO OPACO
- ALTRA FINITURA RAL _____
- BICOLORE RAL _____

ACCESSORI

- MANIGLIA INOX NERO
- CHIUDIORTA ARGENTO NERO
- CERNIERE ARGENTO NERO BIANCO

- MANIGLIONE TIPO LEVA _____
 - MANIGLIONE TIPO PUSH _____
- ⚠ TASSATIVO VERIFICARE DIMENSIONI MINIME COME DA CATALOGO**

- COPRIFILI ANGOLARI 40X20 MM
- SENZA FASCIONE INTERMEDIO
- FERMAVETRI LATO A TIRARE / CERNIER
- VETRI INCAMERATI
- VETRI NON INCAMERATI
- VETRI NON INCAMERATI CON PELLICOLA UV

Cliente _____ Rif. ordine / Offerta _____ Data ____ / ____ / ____ Rif. _____ Ubicazione _____

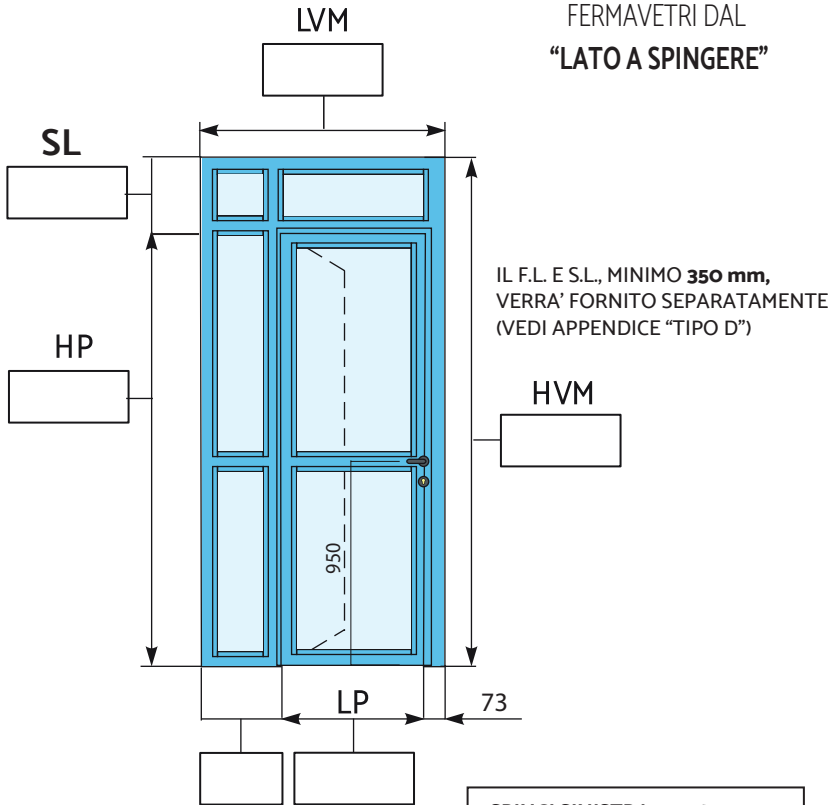

TIPOLOGIE DI TELAIO

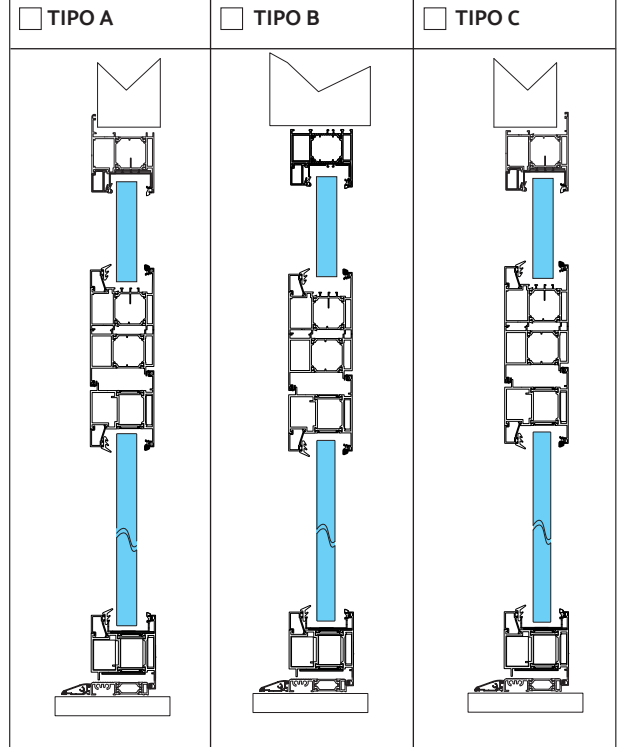

TIPOLOGIE DI FISSAGGIO

- FORI DI ANCORAGGIO PER SOTTOSTRUTTURA
- FORI DI ANCORAGGIO PER TASSELLI

FINITURE

- DI SERIE - RAL 9010 LISCIO OPACO
- ALTRA FINITURA RAL _____
- BICOLORE RAL _____

ACCESSORI

- MANIGLIA INOX NERO
- CHIUDIORTA ARGENTO NERO
- CERNIERE ARGENTO NERO BIANCO

- MANIGLIONE TIPO LEVA _____
- MANIGLIONE TIPO PUSH _____

⚠ TASSATIVO VERIFICARE DIMENSIONI MINIME COME DA CATALOGO

- COPRIFILI ANGOLARI 40X20 MM
- SENZA FASCIONE INTERMEDIO
- FERMAVETRI LATO A TIRARE / CERNIER
- VETRI INCAMERATI
- VETRI NON INCAMERATI
- VETRI NON INCAMERATI CON PELLICOLA UV

ANTA-TELAIO

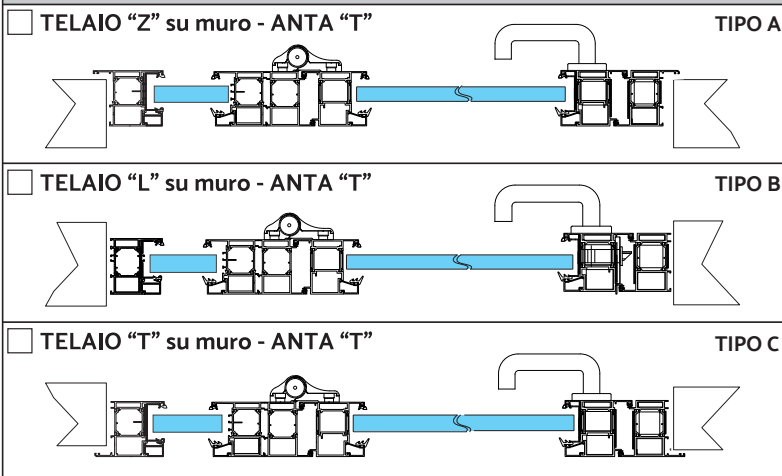

NOTE:

Timbro e firma per accettazione

ALU GLASS • PORTA 1 BATTENTE COMPLESSA

Cliente _____ Rif. ordine / Offerta _____ Data ____ / ____ / ____ Rif. _____ Ubicazione _____

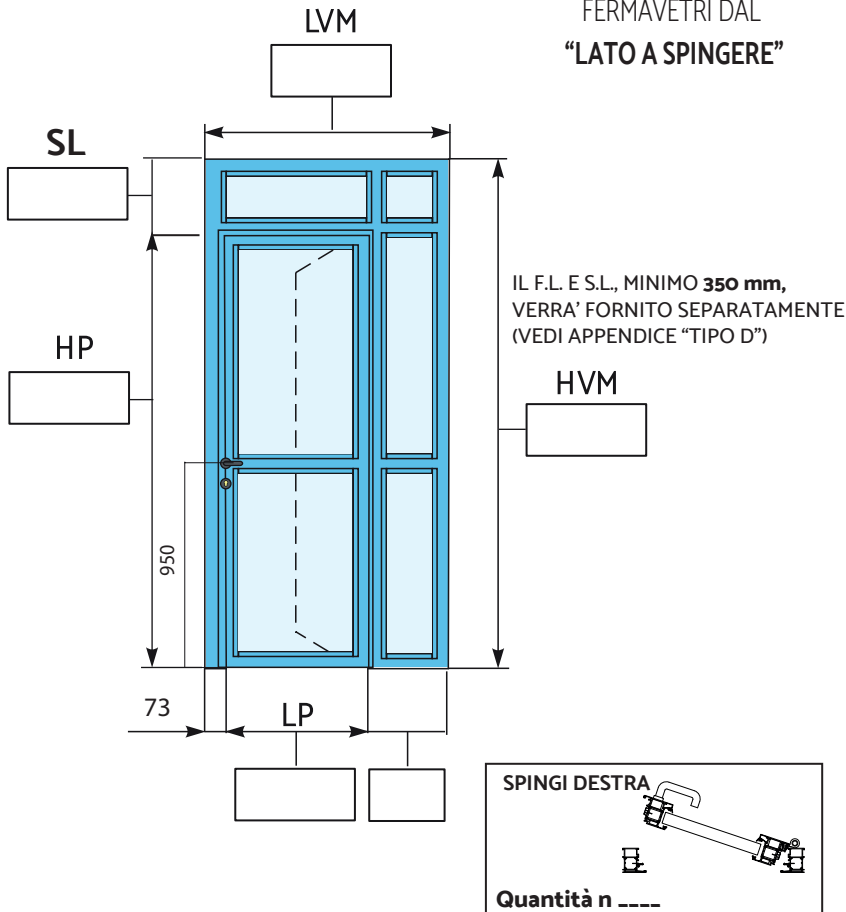

TIPOLOGIE DI TELAIO

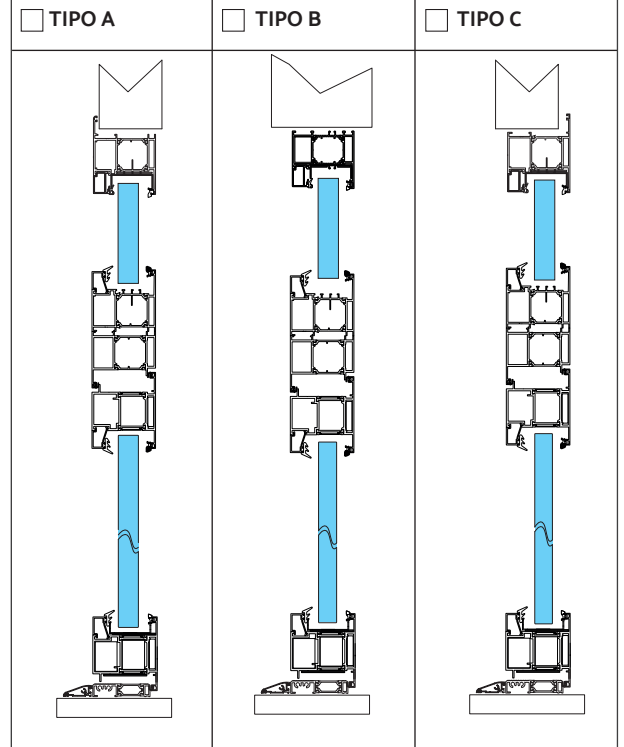

TIPOLOGIE DI FISSAGGIO

- FORI DI ANCORAGGIO PER SOTTOSTRUTTURA
 FORI DI ANCORAGGIO PER TASSELLI

FINITURE

- DI SERIE - RAL 9010 LISCIO OPACO
 ALTRA FINITURA RAL _____
 BICOLORE RAL _____

ACCESSORI

- MANIGLIA INOX NERO
CHIUDIPISTA ARGENTO NERO
CERNIERE ARGENTO NERO BIANCO

- MANIGLIONE TIPO LEVA _____
MANIGLIONE TIPO PUSH _____

TASSATIVO VERIFICARE DIMENSIONI MINIME COME DA CATALOGO

- COPRIFILI ANGOLARI 40X20 MM
 SENZA FASCIONE INTERMEDIO
 FERMAVETRI LATO A TIRARE / CERNIER
 VETRI INCAMERATI
 VETRI NON INCAMERATI
 VETRI NON INCAMERATI CON PELLICOLA UV

ANTA-TELAIO

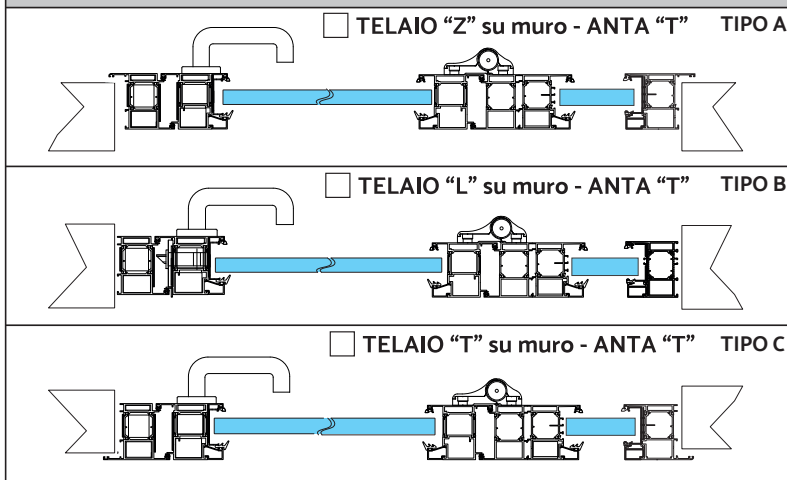

NOTE:

Timbro e firma per accettazione

Cliente _____ Rif. ordine / Offerta _____ Data ____/____/____ Rif. _____ Ubicazione _____

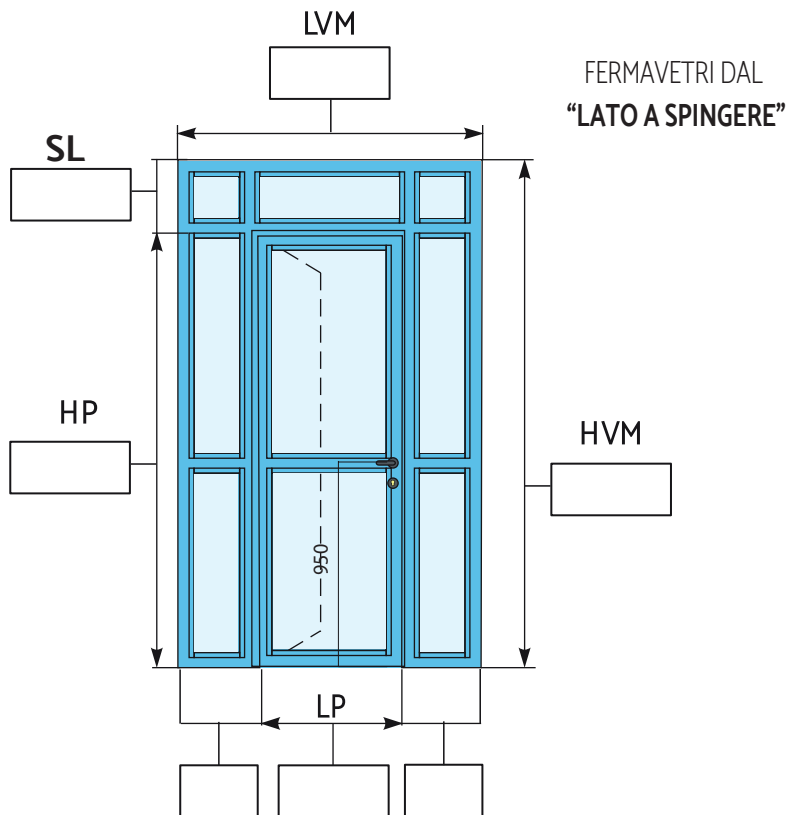

TIPOLOGIE DI TELAIO

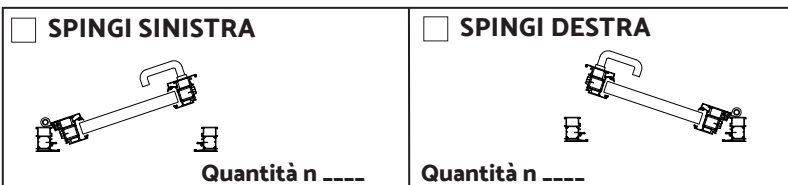
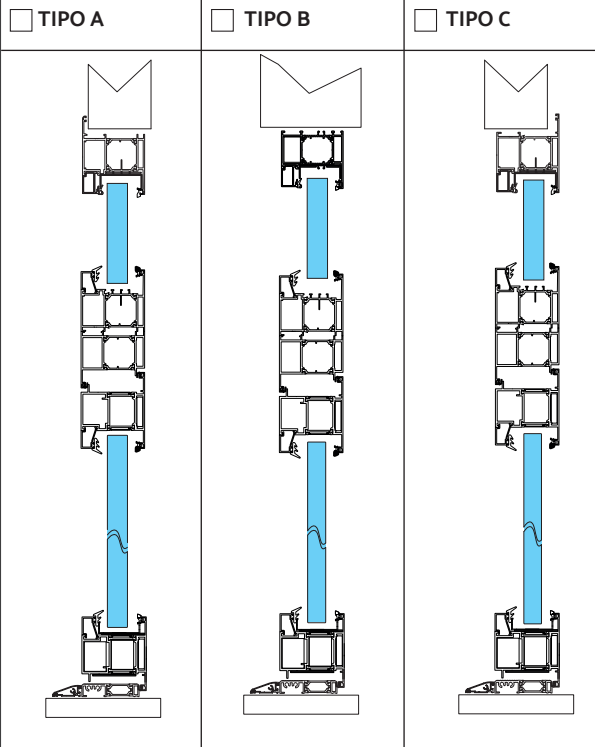

TIPOLOGIE DI FISSAGGIO

- FORI DI ANCORAGGIO PER SOTTOSTRUTTURA
 FORI DI ANCORAGGIO PER TASSELLI

FINITURE

- DI SERIE - RAL 9010 LISCIO OPACO
 ALTRA FINITURA RAL _____
 BICOLORE RAL _____

ACCESSORI

- MANIGLIA INOX NERO
 CHIUDIPISTA ARGENTO NERO
 CERNIERE ARGENTO NERO BIANCO

- MANIGLIONE TIPO LEVA _____
 MANIGLIONE TIPO PUSH _____

TASSATIVO VERIFICARE DIMENSIONI MINIME COME DA CATALOGO

- COPRIFILI ANGOLARI 40X20 MM
 SENZA FASCIONE INTERMEDIO
 FERMAVETRI LATO A TIRARE / CERNIER
 VETRI INCAMERATI
 VETRI NON INCAMERATI
 VETRI NON INCAMERATI CON PELLICOLA UV

ANTA-TELAIO

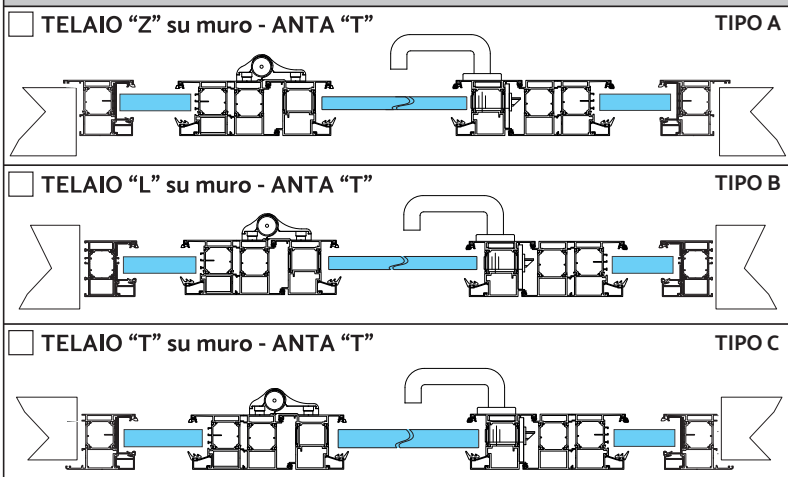

NOTE:

Timbro e firma per accettazione

Cliente _____ Rif. ordine / Offerta _____ Data ____ / ____ / ____ Rif. _____ Ubicazione _____

TIPOLOGIA A

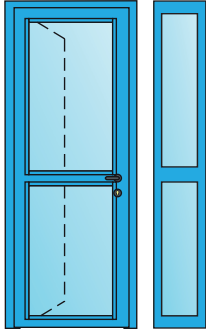

TIPOLOGIA B

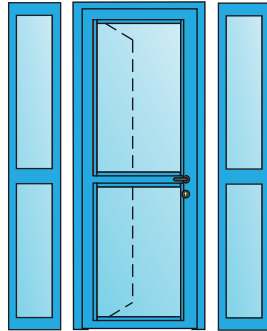

TIPOLOGIA C

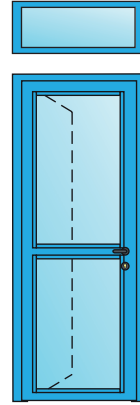

TIPOLOGIA D

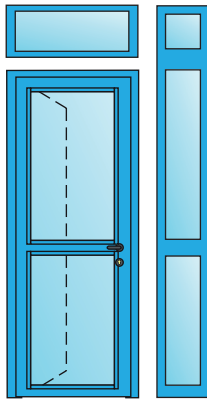

TIPOLOGIA E

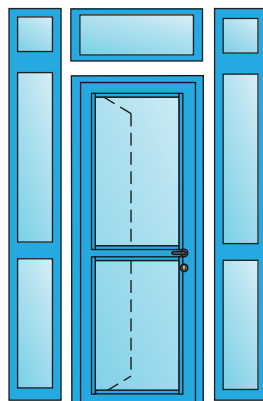

*** SEZIONE DI
SOPRALUCE
SEPARATO DAL
SERRAMENTO**

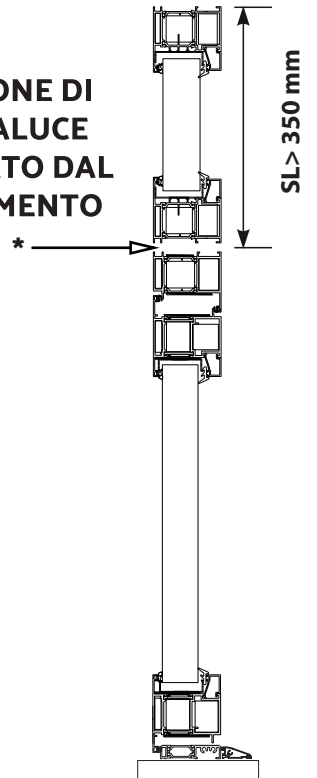

*** SEZIONE DI FIANCOLUCE SEPARATO DAL SERRAMENTO**

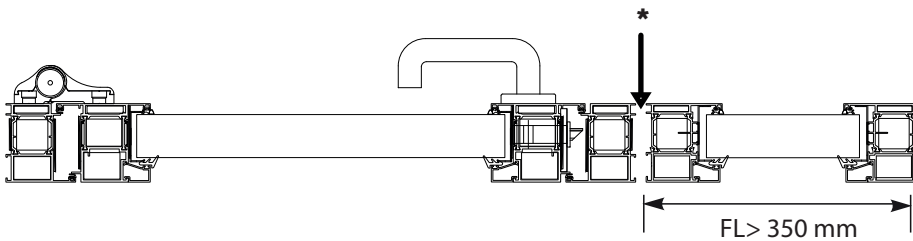

Timbro e firma per accettazione

UFFICIO TECNICO
Tel.: +39 0832 757979 • E-mail: info@glassfire.it

Esprimere le quote in millimetri
I disegni sono esemplificativi e fuori scala
Ed. 06-2024